

OUTLINE COPPER



Kitchen Sinks

Code: 6602 008



DETAILS

Coloring Copper

Edge/Installation Type Flush-mount | Top-mount

Material AISI 304 stainless steel

Texture Brushed in line

Base 90 cm

Dimensions 873x513 mm

Standard fittings Fixing hooks, gasket, drain, overflow and siphon, boxed packing

Mixer holes 2 standard holes - 3rd hole on request

Built-in hole View technical data sheet

Drainer No

Number of bowls 1 bowl

Waste fitting 3,5" drain

EQUIPMENT

8407 122 - Space Push
automatic waste fitting
8100 606 - Black grid
8100 607 - Black grid

FEATURES

Deep bowls This bowls reach an important depth, over 20 cm, thanks to the advanced production technology, that can be offer great capieny and practicity in all the washing operations.

High thickness 1mm thick steel. A significant thickness, which guarantees the maximum sturdiness and durability.

Perimetral overflow The overflow is always a security on the Foster sinks that prevents the overflow of water in case of oversights. The perimeter drain solution improves aesthetics thanks to its square and essential shape.

Small radius Bowls with squared shapes with a modern design and an increased capacity, for a minimal aesthetics connected with an extreme practicity.

Space waste fitting The elegant SPACE steel cap closes the drain and leaves no visible residues collected in the basket below. Space also has a small footprint and allows the optimal use of the under-sink compartment.

TECHNICAL DATA

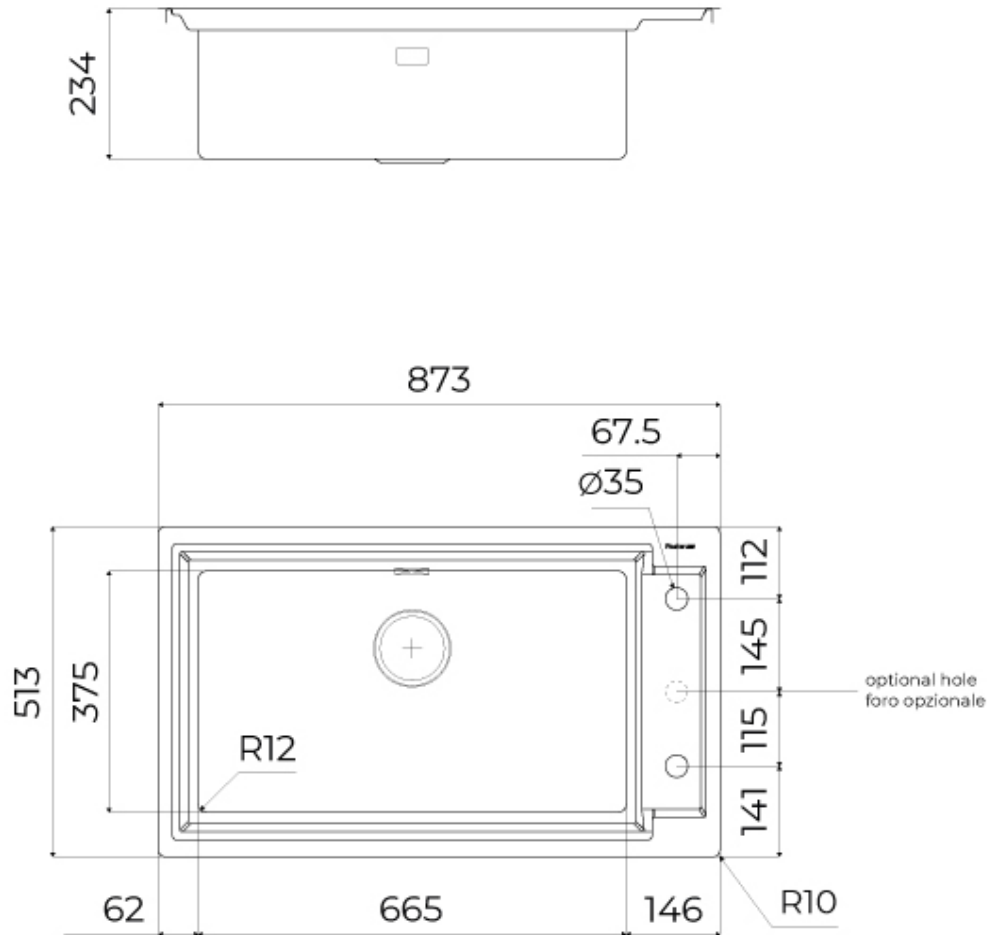

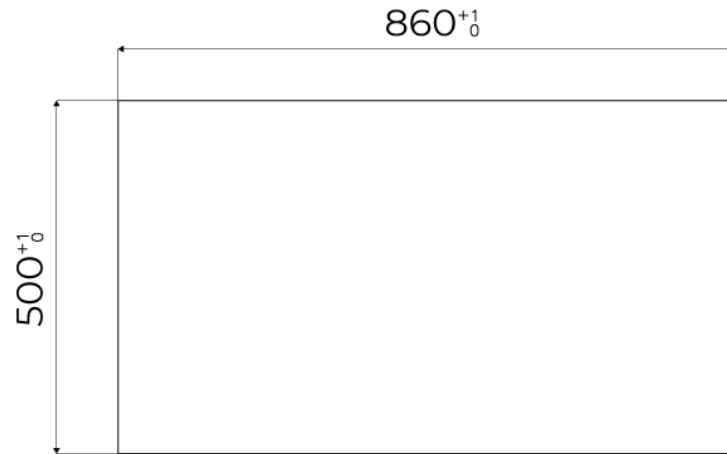

FTS - cut out

FT - cut out

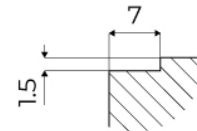
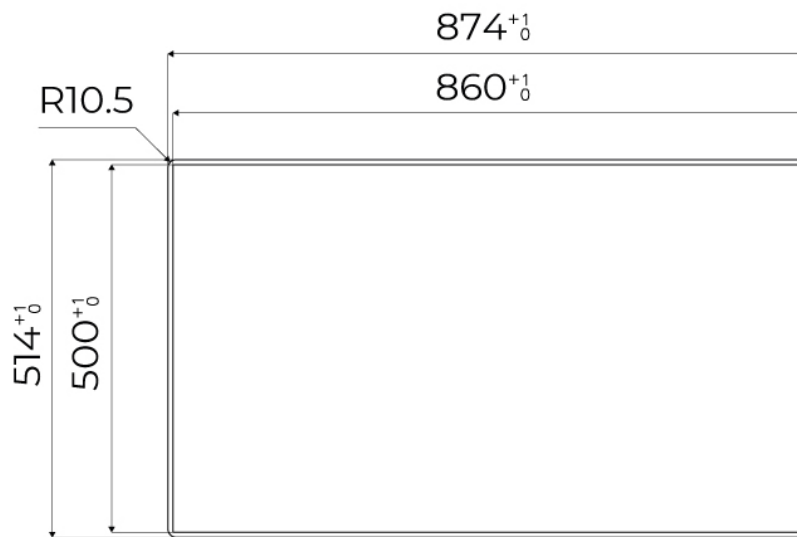

GALLERY

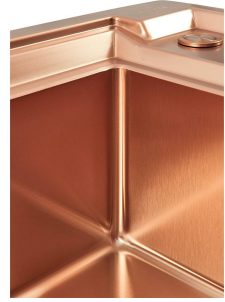
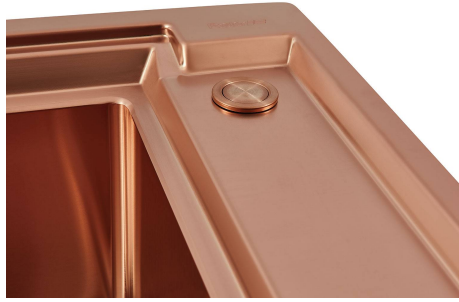

EQUIPMENT



Black Grid
8100 606



Black Grid
8100 607



**Space Push Copper automatic
waste fitting**
8407 122

OPTIONAL ACCESSORIES



Stainless steel basket
8611 000



Stainless steel perforated tray
8156 000

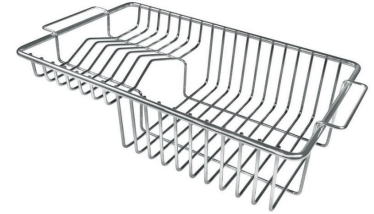

Stainless steel Plate rack
8100 306



Walnut-wood chopping board
8642 004

RECOMMENDED PAIRINGS



OUTLINE GAS - COPPER
7440 008



VELA PLUS COPPER satin
8498 128